



CT6 GPS

OWNERS MANUAL

POWAKADDY.COM



PGA is a registered trade mark of the Professional Golfers' Association Limited.



Thank you for purchasing the all new Powakaddy. Please read the following instructions carefully. Battery care is very important, please refer to Section 14 for detailed instructions.

When you receive your new Powakaddy you will have the following:

1 x Trolley | 1 x Battery | 1 x Charger | 2 x Wheels | 1 x Instruction pack

1 Product Warranty



Register now!
Don't miss out!

Scan to open the registration page
or visit: powakaddy.com/my-powakaddy

Please take a moment to register your new products to receive the *Extended Warranties.

You will be required to enter the serial numbers for the Trolley, Battery and Charger. These are located on the individual items. The serial number on the trolley is located in the rear joint, See image.

**Terms and conditions apply. See powakaddy.com for details.*



2 Getting Started

Remove wheels and frame from the box.

Remove the axle caps and fit the wheels by pressing the release button located on the hub and slide onto the axle until the clutch is engaged. For storage and transit purposes, the wheels can be rotated inwards.

Note: On EBS models only, the wheels can be locked into two positions on the axle; push onto the inner grooves to engage the clutches. The outer grooves can be used when drive is not required.

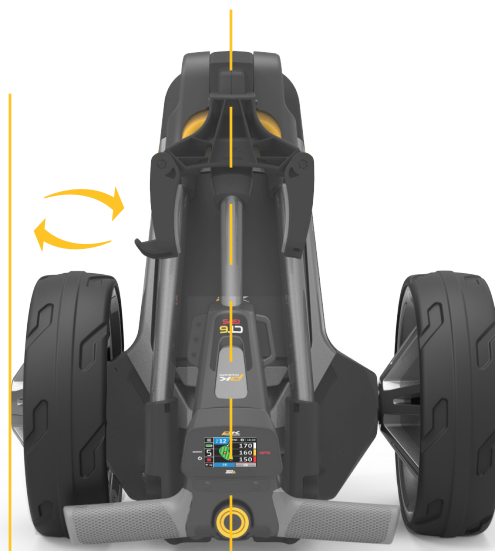

3 Unfold Your Trolley



To open the frame, push the yellow front wheel lever towards the bag stay and rotate the front wheel assembly until it locks into place.

Secondly, press the yellow main lock button and lift the handle until the rear and upper joints click into place. Reverse the process to fold so that the handle hook locks into the rear joint.

4 Lithium Battery

IMPORTANT- you must fully charge your battery before using your trolley. Always recharge your battery within 24 hours of use. Failure to do so could reduce the life of your battery. See Section 14 Battery Care, for detailed instructions.

Your PowaKaddy trolley features an innovative Plug'n'Play™ battery system including sprung terminals and a locking feature to maintain power connection over uneven terrain. Once your battery is charged and trolley assembled, connect your battery as shown.

1. Engage the front of the battery.
2. Press the rear until the battery clips into position.
3. Press the Power button to turn the trolley on.

To remove the battery, first turn off via the power button. Pull the grey latch to disengage the battery before lifting from the frame.

Note: The Lithium battery can be stored within the tray for transportation. Please ensure you turn off the battery using the power button. Leaving your battery on with the Green LED illuminated could lead to your battery discharging or trolley activating during transportation.

Turn on and off via power button



5 Front Wheel Adjust

Your trolley is pre-set to run straight but if your trolley is running off course, adjust by:

1. Release the front wheel lever.
2. Rotate up to make your trolley track more to the LEFT.
3. Rotate down to track more to the RIGHT.
4. Once you are happy the trolley is running straight re-apply the lever to lock in position.



6 Handle Height Adjust

The handle height is pre-set to suit most users but can be adjusted to one of five positions. To adjust:

1. With the trolley fully open, remove the locking bolt from the height adjust plate using the 4mm hex key supplied in your manual pack.
2. Raise or lower the handle to the new desired position.
3. Tighten the bolt back up ensuring the adjustment plates on both sides are locked into the mating features.



7 Controls Overview

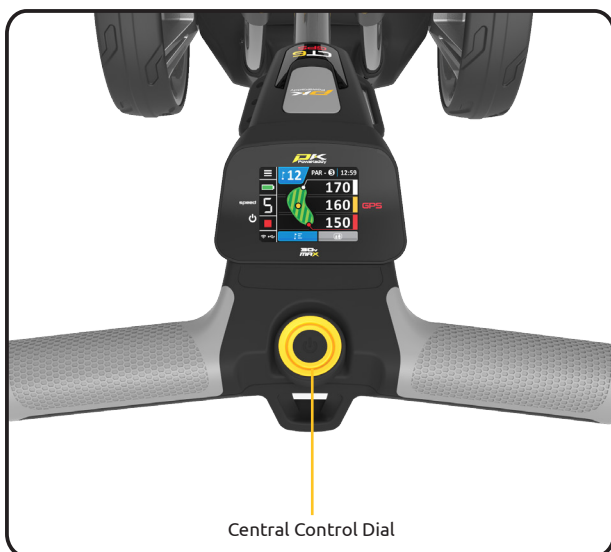

Once your battery is fully charged and connected, your trolley is ready to use.

Note: Your trolley includes a power save mode to extend the life of your battery. After 5 minutes of sitting idle, the trolleys display will turn off. To wake up, press the display or rotate the control dial.

Central Control Dial:

- Rotate to adjust the speed of the trolley from 0 to 9.
- Press to pause and resume the motor at your selected speed.
- Press and hold to activate the automatic distance function.

Touch Display

Press the display with your finger within the highlighted area, *shown left*. Touch to operate menus and settings. Swipe left and right to toggle between GPS measurement modes.

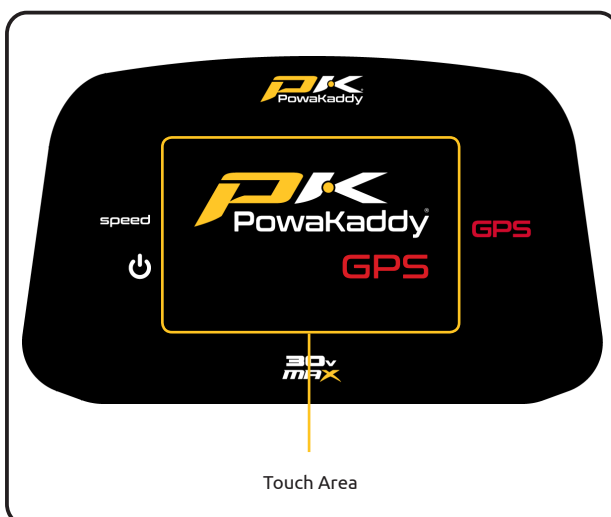

Note: you can operate the display wearing most golf gloves. Results may vary when wearing thick or winter gloves. Keep the display clear of water for best results.

GPS Map Updates:

Your GPS trolley is pre-loaded with over 40,000 course maps. You can update any map using a smartphone via the Powakaddy App. See Section 13 for detailed instructions.

USB Charging Port:

Located on the underside of the handle. Open the hatch to charge GPS & mobile devices. The output is rated to 5v/500mA suitable for most USB devices*

*USB output voltage 5v/500mA compatible with most USB portable devices, please check device manufacturers instructions before use. Powakaddy International Ltd accepts no liability for loss of data or damage from using the charging port with incompatible device.

8 Start Up

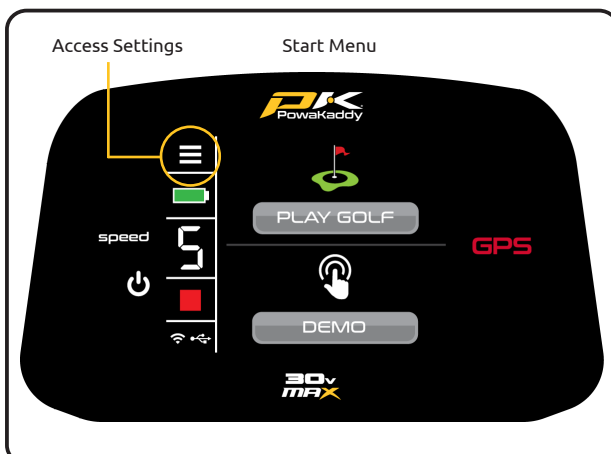

Once your battery is fully charged, and connected, your trolley is ready to use. The display will illuminate showing the Start Menu.

On the left side of the display is the control bar. This displays the trolley speed, battery gauge and is the access point to the Settings Menu. See section 9 for more information.

You can use all motor functions from this screen. To start using the GPS features, select the 'PLAY GOLF' button or alternatively, to quickly view the features of the trolley, select the 'DEMO' button.

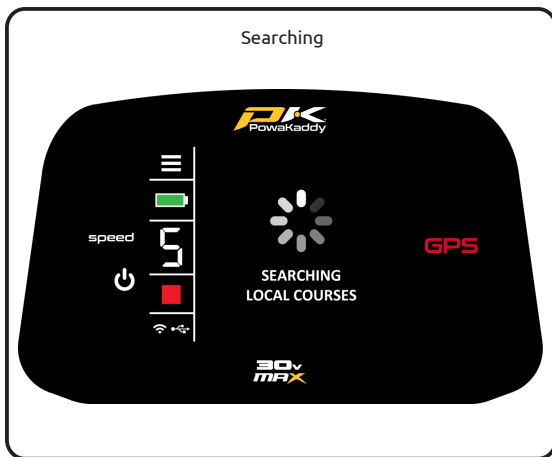

Play Golf:

- The trolley will start searching for GPS signal. This can take up to 5 minutes depending on location and signal strength. For best results, operate away from buildings in an open sky position.
- If no signal is acquired after 5 minutes, a Low Signal message will be displayed. Move to a better GPS signal strength area and the trolley will continue searching.

You can operate the motor functions while the GPS device identifies your location. Once the device has a GPS lock a list of up to 10 local courses will be displayed. Navigate the list by using the up & down arrows on the right side of the display.

Select a Course by:

1. Pressing the desired course from the list. Your selection will turn green.
2. Confirm by pressing the blue 'LOAD COURSE' button at the bottom of the display.
3. The trolley will take a few seconds to load the data.

Demo Mode:

Will allow the user to explore the display screens and trolley function without requiring a GPS signal lock.

- Select 'DEMO' button from the Home Menu.
- The display mimics the trolley searching for a GPS lock and then will present a list of courses for the user to choose from.
- Select the desired course and confirm by pressing the blue 'LOAD COURSE' button.
- Once the data has loaded, swipe left and right between the GPS distance measurement modes and browse the Settings Menu. See Section 10 and 11 for further details.

(Note: the information shown in demo mode is only to demonstrate the product and may not be accurate course information)

- To exit Demo Mode, enter the Settings menu and navigate to page 4. Press the Red 'EXIT DEMO' button.

Please note: no motor functions are available in Demo Mode.

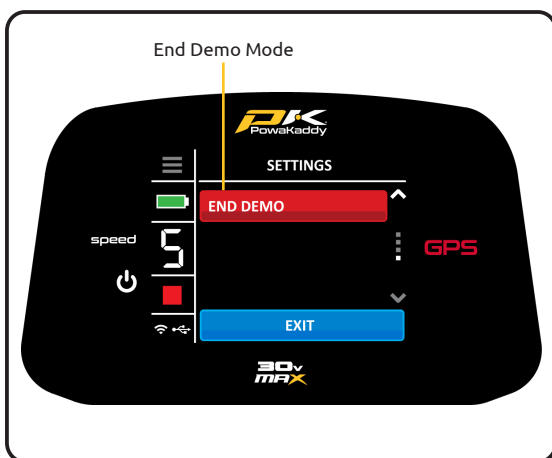
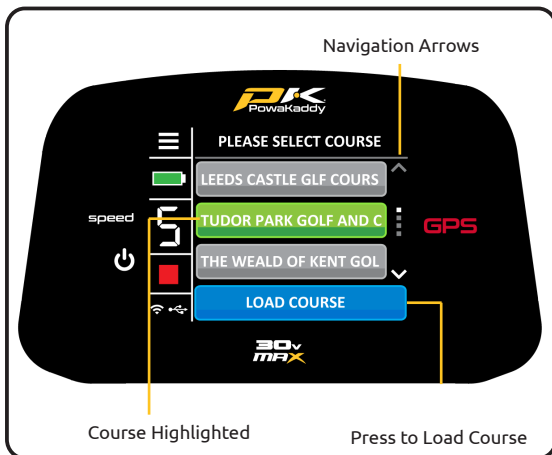

9 Trolley Controls

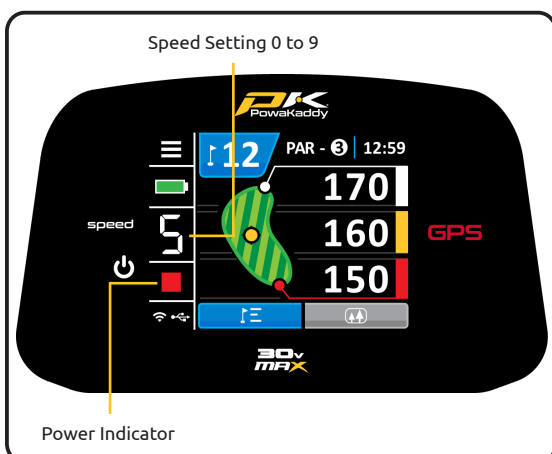

Speed Setting: Rotate the control dial to adjust the speed of the trolley from 0 - 9. Press control dial to start/pause and resume your selected speed.

Note: the motor has a 15 minute timeout function and will pause the motor after running continuously for this duration. Press the control dial to resume.

Power Indicator: Displays whether power is being applied to the drive system. (Green - ON) (Red - OFF)

Automatic Distance Function (ADF): The ADF function is a convenient way of sending your trolley a set distance (5 to 50 yards/metres); for example, when you are approaching a green you can send the trolley towards the next tee if the route allows.

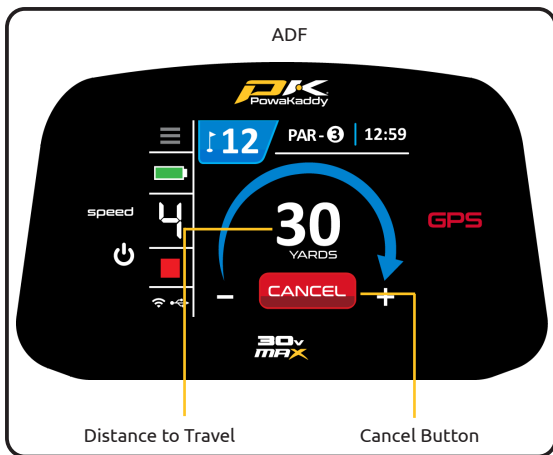

Note: it is not recommended to send your trolley unattended over steep or rough terrain. To activate ADF the motor must be paused and then:

1. Press and hold the control dial until ADF display (left) appears on the screen.
2. Rotate the control dial to select the distance between 5 and 50 (Yards/Metres).
3. To set the trolley in motion, press the control dial to start the motor. The trolley will run by default at speed 4.

To cancel the ADF during set-up, rotate the control dial so "0" is displayed as the distance to travel and confirm by pressing the control dial or alternatively, press the red 'CANCEL' button.

To cancel when the trolley is in motion, simply press the control dial to pause the motor as you would during normal use or alternatively, press the red 'CANCEL' button.

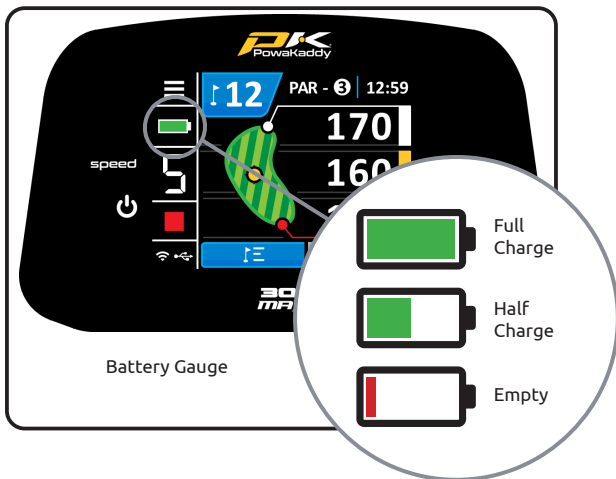

Battery Gauge: located on the left side of the display. The charge state of your battery will determine how much of the bar will illuminate.

As you progress through the round the inner bar of the gauge will drop. When the bar has fully extinguished it indicates that the battery is flat. When your battery is new, the bar may only drop a small amount during the entire round. As your battery ages, you may lose more.

If the bar is completely extinguished; (1) you may not have fully charged your battery (2) your battery is nearing the end of its useful life and should be replaced.

10 GPS Functions

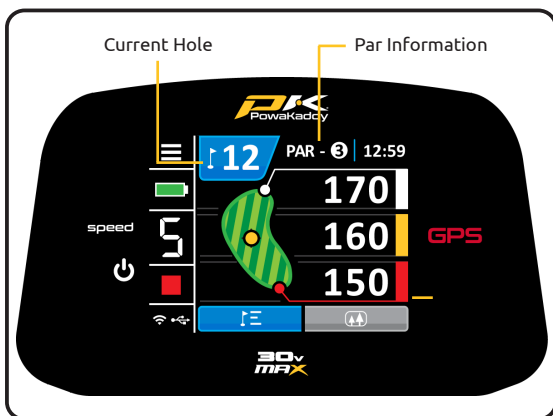

Select Hole:

Once the course data has loaded, your trolley display GPS information for Hole 1. Once you enter the 'tee zone' of the next hole in sequence, the trolley will automatically advance to display information for the next hole.

If you have not entered the mapped 'tee zone', therefore not auto-advancing or you are not starting from the 1st tee; you can select a hole manually. To do so:

- Press the blue 'Hole' graphic at the top of the display.
- A grid displaying holes 1 to 9 is shown. From the grid select the desired hole.
- Hole 10 to 18 are displayed on a second page. Navigate between pages using the arrows on the right side of the screen.
- Once a new hole is selected you will return to the previous display you were on.

The Par info is displayed at the top of the display and will update with every hole.

Clock:

The clock located in the top right corner of the screen displays the current time using GPS data. Adjust for daylight saving hours in the Settings Menu. See Section 11 for more details.

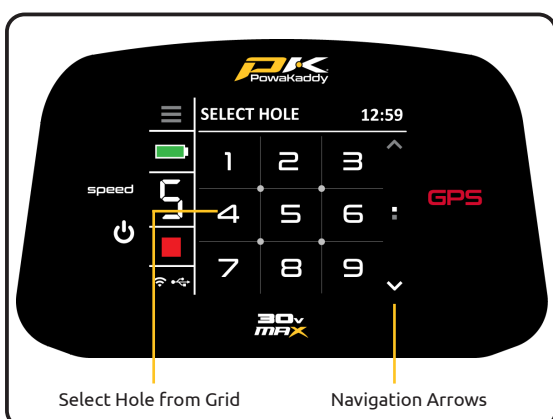

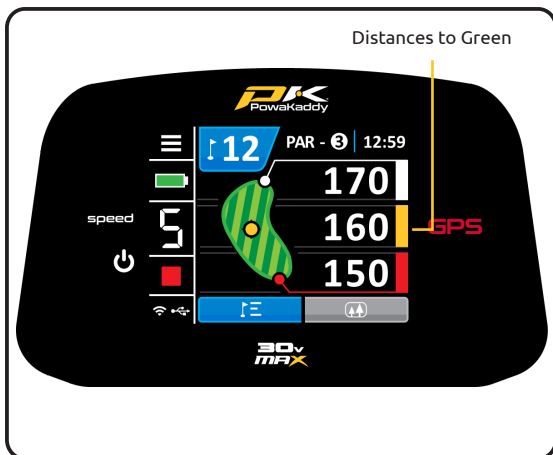

Distances to the Green:

Distances to the Front, Centre and Back of the green are displayed on the right hand side of the display.

Note: The distance units can be changed from Yards to Metres and vice versa in the Settings menu at any time. See Section 11 for more details.

Hazards:

To access the Hazard screen from the Distances to the Green display, swipe across the screen from left to right or right to left. (Repeat to return to the Distances to the Green display).

A maximum of 4 hazards are mapped on each hole. As you pass the hazard it is removed from the screen. Three categories of hazards are mapped; Bunkers, Water hazards and End of Fairways. These are depicted using 3 different symbols as shown below.

The measurement displayed for each hazard can be to the front, middle or back of the hazard depending on the description i.e CRKC - Creek Carry. Find all hazard descriptions on the next page.

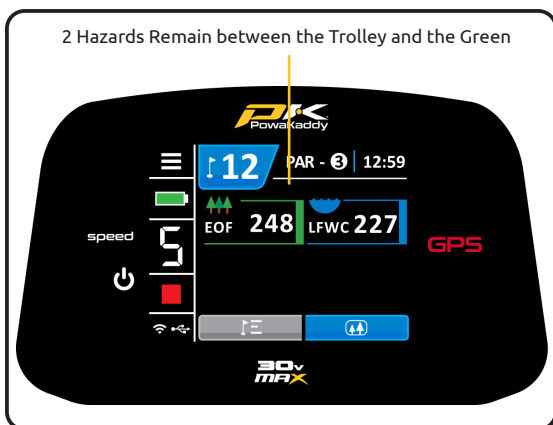
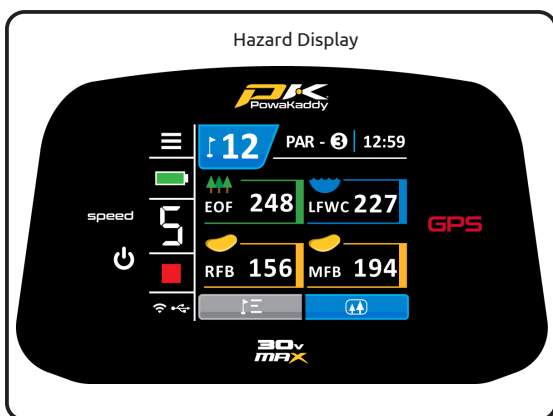

BUNKER



WATER HAZARD



END OF FAIRWAY

Competition Mode:

For use in competitions where distance features are not permitted. All distance measuring features will be disabled.

- Competition Mode can be activated and deactivated from the Settings menu.
- When the trolley is switched off, Competition Mode will automatically disable, re-activating distance features for the next round.

Round Info:

Enter the Settings Menu by pressing the white icon in the top left corner of the display and select the 'ROUND INFO' option by pressing the arrow located to the right of the text.

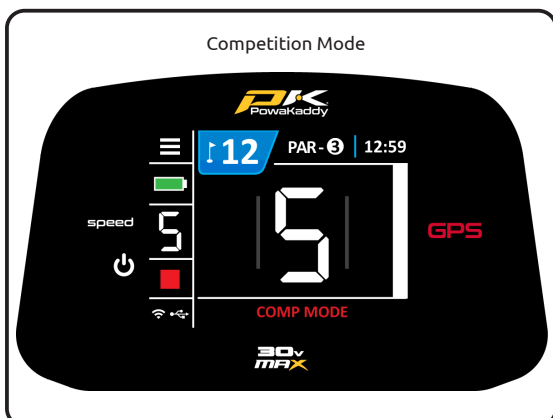

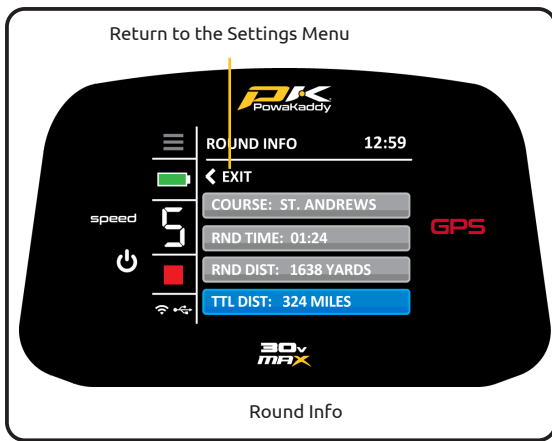

Displayed is:

- **Course:** The current course selected. Change course by selecting 'END ROUND' on page 4 of the Settings Menu and then re-select 'PLAY GOLF'.
- **Round Time and Round Distance:** Displays the "on" time of the trolley and the distance the trolley has travelled during the round. This will reset when the battery is disconnected.
- **Total Distance:** Displays the total distance the trolley has travelled.

Press the 'EXIT' arrow to return to the settings menu followed by the blue 'EXIT' button to return to the GPS Distances.

Note: Round Info is only available when a course has been loaded via the 'PLAY GOLF' mode.

Hazard Descriptions

Fairway Hazards

- LFB - LEFT FAIRWAY BUNKER**
Distance taken from the FRONT of the hazard
- MFB - MIDDLE FAIRWAY BUNKER**
Distance taken from the FRONT of the hazard
- RFB - RIGHT FAIRWAY BUNKER**
Distance taken from the FRONT of the hazard
- LFW - LEFT FAIRWAY WATER**
Distance taken from the FRONT of the hazard
- LFWC - LEFT FAIRWAY WATER CARRY**
Distance taken from the BACK of the hazard
- MFW - MIDDLE FAIRWAY WATER**
Distance taken from the FRONT of the hazard
- MFWC - MIDDLE FAIRWAY WATER CARRY**
Distance taken from the BACK of the hazard
- RFW - RIGHT FAIRWAY WATER**
Distance taken from the FRONT of the hazard
- RFWC - RIGHT FAIRWAY WATER CARRY**
Distance taken from the BACK of the hazard

Green Side Hazards:

- BGB - BACK GREEN BUNKER**
Distance taken from the FRONT of the hazard
- FGB - FRONT GREEN BUNKER**
Distance taken from the FRONT of the hazard
- LGB - LEFT GREEN BUNKER**
Distance taken from the FRONT of the hazard
- RGB - RIGHT GREEN BUNKER**
Distance taken from the FRONT of the hazard
- FGW - FRONT GREEN WATER**
Distance taken from the FRONT of the hazard
- FGWC - FRONT GREEN WATER CARRY**
Distance taken from the BACK of the hazard
- LGW - LEFT GREEN WATER**
Distance taken from the FRONT of the hazard
- RGWC - RIGHT GREEN WATER CARRY**
Distance taken from the CARRY of the hazard

Miscellaneous Hazards

- EOF - END OF FAIRWAY**
Distance taken from the BACK of the hazard
- CRK - CREEK**
Distance taken from the FRONT of the hazard
- CRCK - CREEK CARRY**
Distance taken from the BACK of the hazard

11 Settings

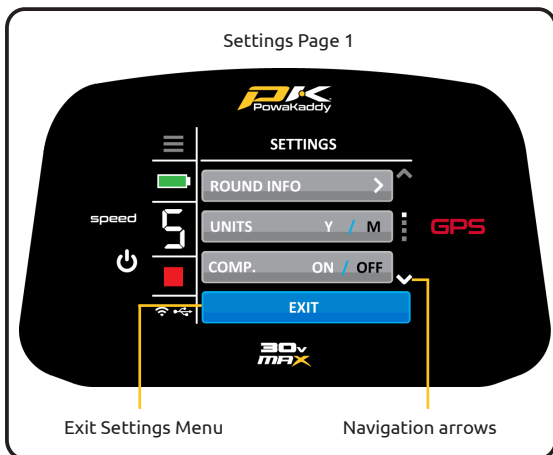

Your new GPS trolley is ready to use but there are a few preferences you may change. To enter the Settings Menu, press the icon in the top left hand corner of the display.

To exit, press the blue 'EXIT' button at the bottom of the screen. If you have made any changes to settings, when you exit please allow your new preferences to save. **DO NOT** turn the trolley off.

Navigate the 4 pages by pressing the arrows located on the right of the display.

Settings Options:

ROUND INFO:

Displays information regarding round time and distance. Only available once a course has been loaded via PLAY GOLF. See section 10 for more information.

UNITS:

Change between 'Y' (Yards & Miles) and 'M' (Metres & Km). Press the 'Y' or 'M' to make the selection. The one highlighted White is the active selection. All measurements will be shown in this selection including the GPS measurements and the ADF distances.

COMP.:

Activate and deactivate Competition Mode by selecting 'ON' or 'OFF'. The one highlighted White is the active selection. Competition Mode will default to off when the trolley is powered off.

TIME:

Adjust for daylight saving hours by pressing the plus '+' and the minus '-' symbols.

PIN:

Activate or deactivate the Security Pin function by selecting 'ON' or 'OFF'. The one highlighted White is the active selection.

To set the pin:

- Change the selection to 'ON'.
- Enter a 4-digit code of your choosing.

If the PIN lock is active you will be required to enter your PIN code each time you power the trolley. In the event you have forgotten the code use the default factory PIN: 7921 to unlock the controls.

Deactivate the pin by selecting the 'OFF' option.

CONNECTIVITY (Paired/Not Paired):

Displays connection status with mobile device. To Pair a device, see section 14.

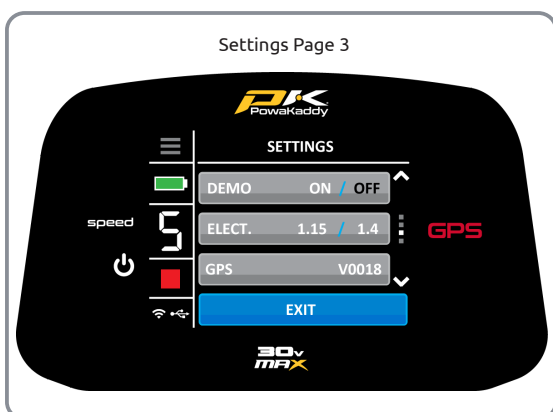
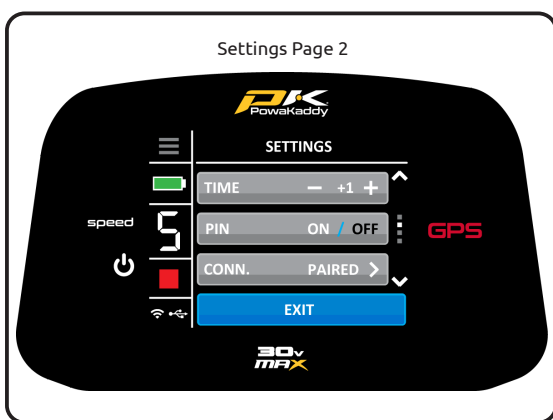

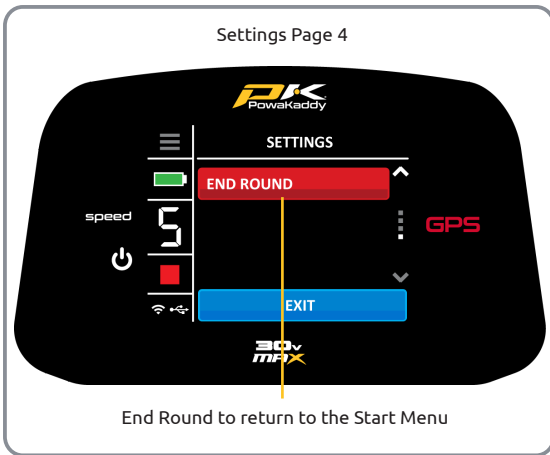

DEMO:

Enable and disable the Demo Mode function from the Start Menu by selecting 'ON' or 'OFF'. The one highlighted White is the active selection.

ELECT: Software version of the handle and motor speed controller.

GPS: GPS Firmware version installed on the handle. (Required in the PowaKaddy GPS App).

END ROUND: Select this red button to return to the Start menu.

12 Electronic Braking System

EBS

The all new Electronic Braking System (EBS) is an option extra feature on the PowaKaddy CT range.

The EBS is an automatic assisted braking system for downhill descents, maintaining the selected speed to prevent the trolley running away from the user. In addition, the trolley will hold a selected speed uphill, removing the need for constant adjustment of the control dial.

Warning: EBS is an assisted braking system for hill descent, not a 100% parking brake. The trolley must be powered on and the wheels engaged with the clutch for the braking system to function. The drive system uses a limited slip differential to allow braking and provide ease of manoeuvrability. Try to avoid traversing a steep hill as the load of the trolley will mostly be applied to the lower wheel on the slope and may cause the higher wheel to slip. If your trolley loses traction and the wheels start to spin, reduce the speed and apply even pressure on the handle to increase traction of both wheels.

Caution: Wet or loose ground conditions may cause the wheels to lock and slip on steep slopes. When walking up, down or traversing slopes, please maintain a firm grip on the handle to assist the trolley and avoid injury or damage.

13 GPS Updates

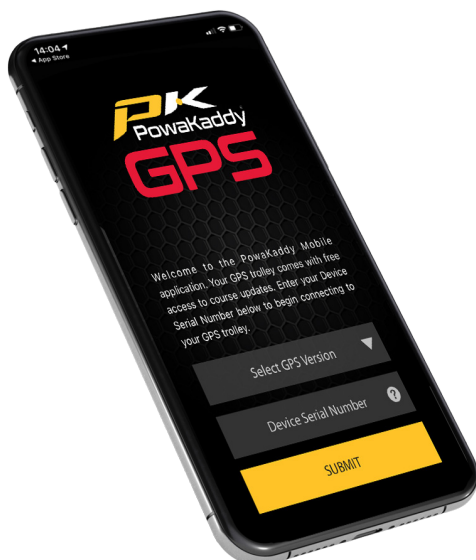

Your GPS trolley comes loaded with over 40,000 worldwide course maps and can be updated as new map data is available. The maps can be individually updated via Bluetooth using the PowaKaddy App, available to download from the Apple App store and the Google Play store.

1. Download the free PowaKaddy App from the Google Play Store or the Apple App Store.
2. Select the GPS Version of your trolley from the drop down box. Your GPS Version number is found on the 3rd Page of the Settings Menu. See Section 11 for details.
3. Enter your trolley Serial number found in the rear joint of the trolley.



To Pair the phone to the trolley:

1. Power the trolley and enter the 'CONNECTIVITY' option located in the Settings Menu.
2. On the phone, select the yellow 'Pair Device' button.
3. The trolley will display a 6-digit pairing code, enter this into the app.
- 4.

If having difficulties pairing:

- Ensure no other PowaKaddy GPS trolleys powered close by.
- Try closing the app and restarting the trolley, the pairing process may have timed out.

Note: once paired with your smartphone, the trolley will remember the connection.

To update a course map:

1. From the App menu, select 'Update course'.
2. Either use your smartphone's GPS to pinpoint your location or use the search bar. Select the required course from the list and the trolley will start the update. Please do not remove or turn off the battery during the update.
3. Once the update has finished, please restart the trolley. It will now load with the updated data.



Google Play is a trademark of Google Inc.
App Store is a service mark of Apple Inc.

14 Battery Care

Note: the STANDARD 30V Lithium Battery is designed for use over 18 holes and must always be fully charged before the next round. Please follow charging instructions as outlined on the following pages. We are aware that some golfers will try to stretch these batteries to 27 holes. This may damage the overall capacity of the battery and may result in an early failure. Playing more than 18 holes with the STANDARD battery can seriously shorten the battery's life and will invalidate the battery's warranty.

Note: in normal conditions the XL Extended 30V Lithium Battery will do 36 Holes when used on a PowaKaddy product. Conditions such as long or exceptionally hilly courses, wet ground conditions and excessively heavy golf bags may reduce the range of the trolley.

PLUG 'N' PLAY™



30v MAX

Charging Instructions

1. Plug the charger into the mains - the charger indicator light will be green.
2. Turn on the battery by press and holding the power button until the green light is illuminated.
3. Plug the battery into the charger. The charger light will turn from green to red to indicate the charging process has started.
4. Once the battery is fully charged, the charger status light will be continuous green. At this point, remove the battery from the charger and the charger from the outlet.
5. Turn off the battery using power button.
6. The charging process will take approximately 8 hours depending on the extent of the discharge and battery capacity.

7. Avoid leaving your battery on charge for longer than 12 hours. If left for a long period of time, the battery will automatically turn off.



Battery Safety

- Never short circuit a battery. Keep it away from paper clips, coins, keys and other small metal objects that can make a connection between the terminals.
- Do not splash or immerse in liquids.
- Do not store or charge the battery in locations where the temperatures may exceed below -10° (14° F) or above 40° C (105° F) such as outdoor sheds or metal buildings in summer.
- Only charge your PowaKaddy battery using the approved charger supplied. Using another charger may damage the battery or cause fire.
- Never use the battery if the casing or terminals are damaged.
- There are no serviceable parts within the battery, DO NOT ATTEMPT TO OPEN THE BATTERY or attempt a repair. RISK OF ELECTRIC SHOCK OR FIRE.
- The battery is a sealed unit. In the unlikely event liquid leaks from the battery, do not touch the liquid as it may cause irritation or burns.

Follow these precautions:

- Skin contact – Wash with soap and water.
 - Inhalation – Expose to fresh air and seek medical advice.
 - Eye contact – Immediately wash with water for at least 15 minutes. Seek medical attention.
 - Disposal – wear gloves to handle the battery and dispose of immediately; contact your local council or recycling centre.
- Do not incinerate the battery even if damaged.
 - Only use a PowaKaddy Battery with a compatible PowaKaddy Trolley. Use of the battery pack on other products may create risk of injury or fire.

Charging Safety

- Do not probe terminals with conductive objects.
- Only charge a PowaKaddy battery using the supplied PowaKaddy charger. The charger and battery pack are specifically designed to work together.
- Only charge on a hard, flat surface.
- The charger will get warm, do not cover the charger.
- Do not expose the charger to rain or snow.
- Do not use a charger if the plug, leads, contacts or casing is damaged.
- Remove the plug with care Do not pull on the cord.
- Avoid using an extension cable.

Lithium Battery Storage

Batteries are to be stored in a cool and dry place away from direct sunlight and excessive heat or cold; ideally store at room temperature. Charge your battery fully before storing. Charge once every three months thereafter.

Battery Transportation

Ensure the battery is turned off when transporting the trolley to avoid activating the trolley and discharging the battery. Check with your airline before attempting to ship your battery by air.

Lithium Battery Disposal

At the end of its useful life, please discard the battery with due care for the environment.

1. If possible, run down the battery completely and remove from the trolley.
 2. Take the battery to your local recycling centre.
-

15 Maintenance

Your PowaKaddy trolley is easy to maintain.

- Never jet wash or immerse in water. Clean the trolley using a sponge and warm water to remove mud, grass and other debris.
- Occasionally remove the wheels and apply grease to the axles and moving parts.

Your serial number can be found in the cavity of the rear joint, please make a note for future reference.

Should you experience a problem with your PowaKaddy product, please visit www.powakaddy.com/support



The POWAKADDY name and PK logo are registered trade marks of Powakaddy International Limited and are protected in the UK and other countries and regions. In addition, Powakaddy International Limited owns various design registrations, patents and other IP rights in connection with their products.

Only Powakaddy International Ltd and its authorised stockists and licensees may use the Powakaddy logo, product logos and images in advertising, promotional and sales materials, subject to terms and conditions.

Powakaddy International Ltd is registered in UK. Company No. 07747629, UK Trade Mark Registration No. 3593096



Register now!
Don't miss out!

Scan to open the registration page
or visit: powakaddy.com/my-powakaddy



PGA is a registered trade mark of the Professional Golfers' Association Limited.